

IT enclosures
SYSMATRIX

HOW-TO? INSTRUCTIONS

WJF

**EN
ES
RU
PT**

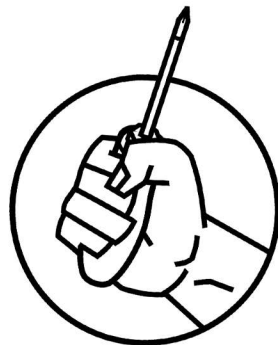

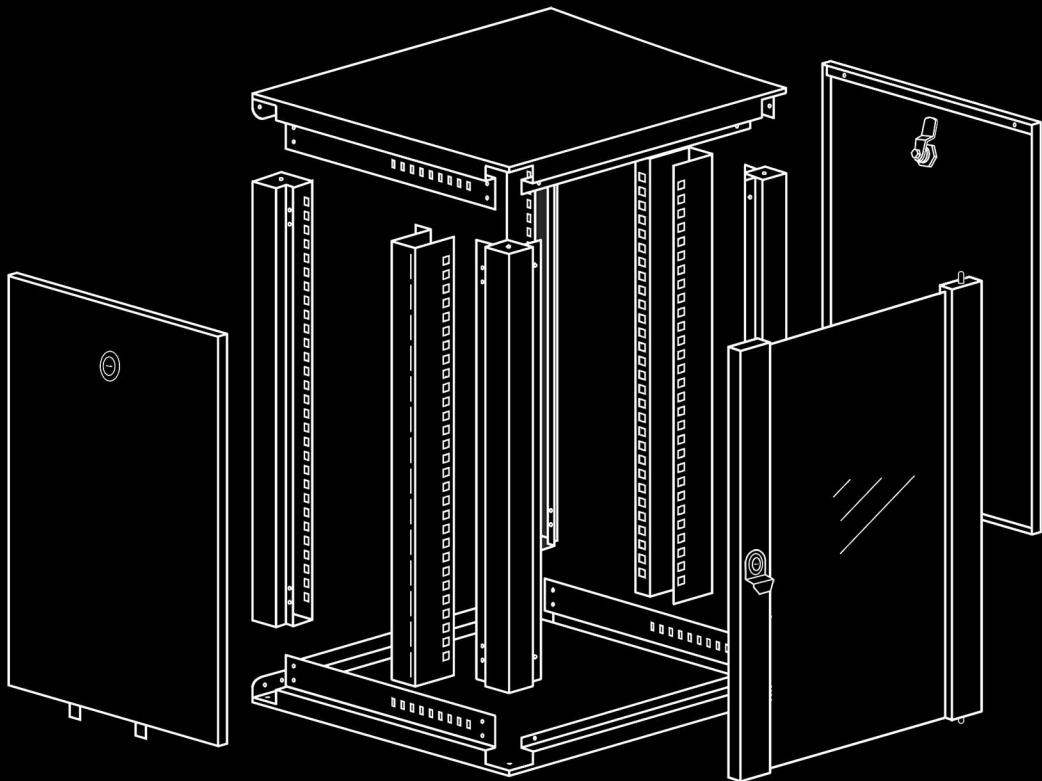

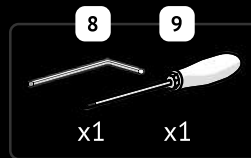
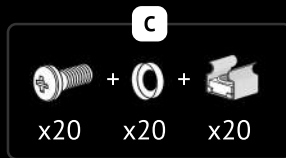
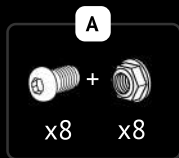
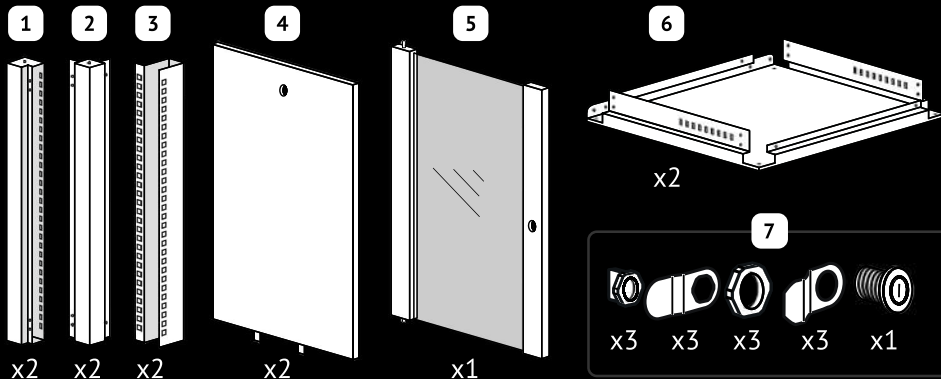

1 *EN* Profile of the main structure (front).
PT Perfil da estrutura principal (frente).
ES Perfil de la estructura principal (frente).
RU Профиль основной конструкции (передний).

2 *EN* Profile of the main structure (rear).
PT Perfil da estrutura principal (traseira).
ES Perfil de la estructura principal (traseiro).
RU Профиль основной конструкции (задний).

3 *EN* 19 inch mounting rail.
PT Trilho de montagem de 19 polegadas.
ES Carril de montaje de 19 pulgadas.
RU 19 дюймовый монтажный профиль.

4 *EN* Side panel.
PT Painel lateral.
ES Panel lateral.
RU Боковая панель.

5 *EN* Glass Door.
PT Porta de vidro.
ES Puerta de vidrio.
RU Дверка с обзорным стеклом.

6 *EN* Roof / bottom.
PT Telhado / fundo.
ES Techo / fondo.
RU Крыша / дно.

7 *EN* The lock.
PT O bloqueio.
ES La cerradura.
RU Замок.

8 *EN* Hexagon key.
PT Chave hexagonal.
ES Llave hexagonal.
RU Шестигранный ключик.

9 *EN* Screwdriver.
PT Chave de fenda.
ES Destornillador.
RU Отвертка.

A *EN* Screw and nut M6.
PT Parafuso e porca M6.
ES Tornillo y tuerca M6.
RU Винт и гайка M6.

B *EN* Self-tapping screws.
PT Parafusos auto-roscentes.
ES Tornillos autorroscentes.
RU Саморезной винт.

C *EN* M6 Cage Nuts & Screws.
PT M6 gaiola Nuts & Parafusos.
ES M6 tuercas Jaula y Tornillos.
RU Комплект крепежа.

English

! **ATTENTION!** Before assembly, carefully inspect the contents of the package for damage and completeness of delivery. In case of damage, note your comments in the delivery service. Also, if any missing parts or damage, notify the supplier.

1 Combine the roof "6", the bottom "6" and the profiles "1-2" into a single structure:

- from above and from below with screws with hexagonal head M6 "A";
- on the sides, using self-threading screws "B".

2 In the front part inside the cabinet, install the 19 inch mounting profiles "3". Using the "C" mounting kit to install the equipment (square clip nut + M6 screw).

3 Install the locks "7" on the side panels "4" and the front door "5" (the lock on the front door is installed with the handle).

4 Install the side panels "4" and the front door "5" (the installation is possible, both on the left and on the right). The door is installed from below on the axle, from above - on the latch.

Español

! **¡ATENCIÓN!** Antes de ensamblar, inspeccione cuidadosamente el contenido del paquete para ver si hay daño y la integridad de la entrega. En caso de daños, anote sus comentarios en el servicio de entrega. Además, si hay piezas faltantes o daños, notifique al proveedor.

1 Combinar el techo "6", el fondo "6" y los perfiles "1-2" en una sola estructura:

- desde arriba y desde abajo con tornillos con cabeza hexagonal M6 "A";
- en los laterales, utilizando los tornillos "B".

2 En la parte delantera dentro del gabinete, instale los perfiles de montaje de 19 pulgadas "3". Utilizando el kit de montaje "C" para instalar el equipo (tuerca de clip cuadrado + tornillo M6).

3 Instale las cerraduras "7" en los paneles laterales "4" y la puerta delantera "5" (la cerradura de la puerta frontal está instalada con el mango).

4 Instale los paneles laterales "4" y la puerta delantera "5" (la instalación es posible, tanto a la izquierda como a la derecha). La puerta se instala desde abajo en el eje, desde arriba - en el pestillo.

Português

! **ATENÇÃO!** Antes da montagem, inspecione cuidadosamente o conteúdo da embalagem para ver se há danos e completude da entrega. Em caso de danos, anote seus comentários no serviço de entrega. Além disso, se houver peças ou danos em falta, informe o fornecedor.

1 Combine o telhado "6", a parte inferior "6" e os perfis "1-2" em uma única estrutura:

- de cima e de baixo com parafusos com cabeça hexagonal M6 "A";
- nos lados, usando parafusos auto-roscados "B".

2 Na parte da frente dentro do gabinete, instale os perfis de montagem de 19 polegadas "3". Usando o kit de montagem "C" para instalar o equipamento (porca de grampo quadrado + parafuso M6).

3 Instale os bloqueios "7" nos painéis laterais "4" e a porta da frente "5" (o bloqueio na porta da frente está instalado com a alça).

4 Instale os painéis laterais "4" e a porta da frente "5" (a instalação é possível, tanto à esquerda como à direita). A porta está instalada de baixo para baixo no eixo, de cima - no trinco.

Русский

! **ВНИМАНИЕ!** Перед сборкой, внимательно осмотрите содержимое упаковки на предмет повреждений и комплектность поставки. При повреждениях, зафиксируйте свои замечания в службе доставки. А так же, при обнаружении недостающих деталей или повреждений сообщите поставщику.

1 Объедините крышу "6", дно "6" и профили "1-2" в единую конструкцию:

- сначала сверху и снизу при помощи винтов с М6 "А";
- затем по бокам, при помощи самонарезающих винтов "В".

2 В передней части шкафа установите 19 дюймовые монтажные профили "3", используя крепежный комплект "С" для установки оборудования (квадратная гайка клипса + винт М6).

3 Установите замки "7" на боковые панели "4" и переднюю дверку "5" (замок на передней дверке устанавливается с ручкой).

4 Установите боковые панели "4" и переднюю дверку "5" (Крепление возможно, как слева, так и справа). Дверка устанавливается снизу на ось, сверху - на защелку.

1

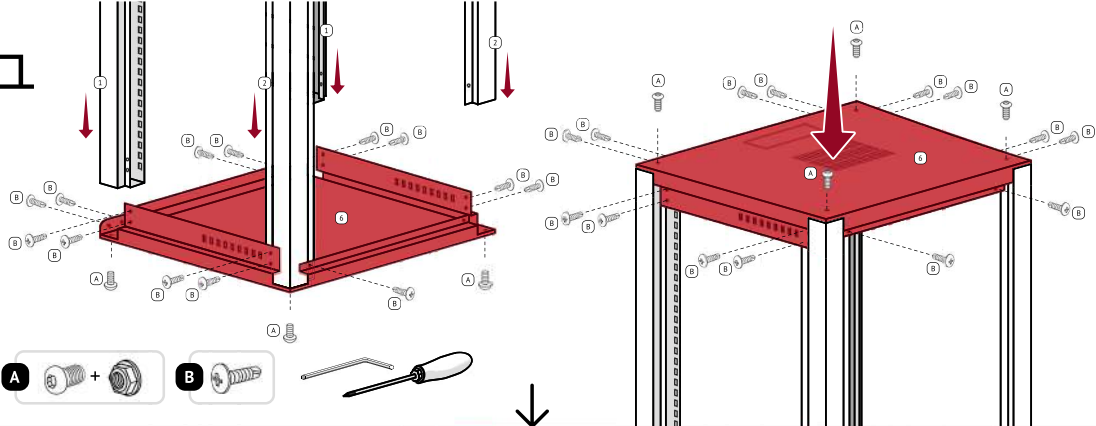

2

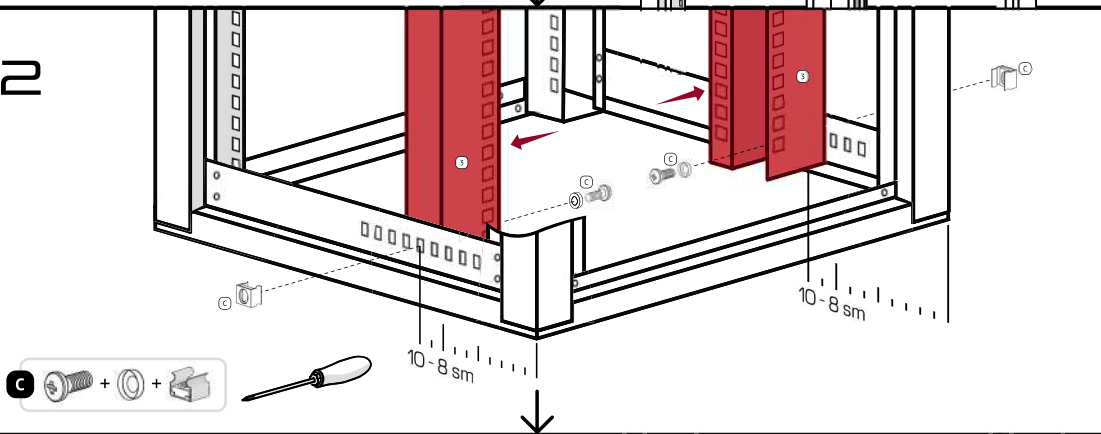

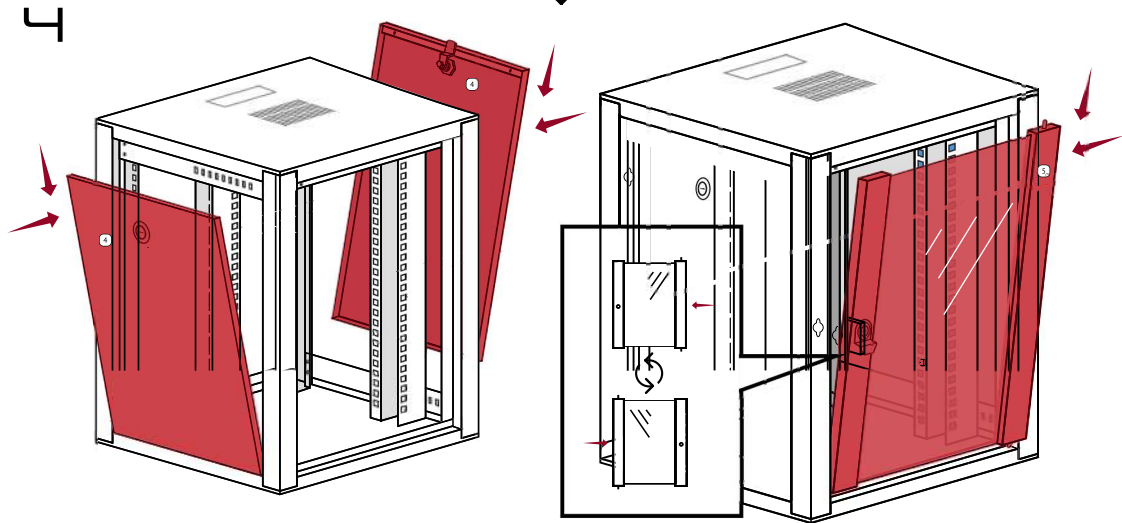
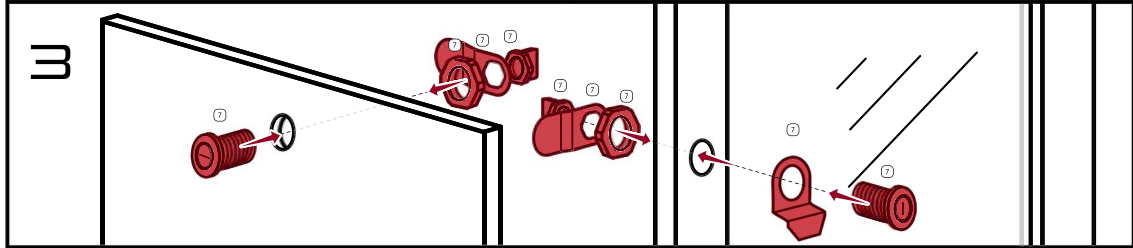

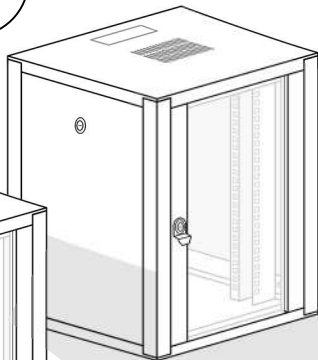
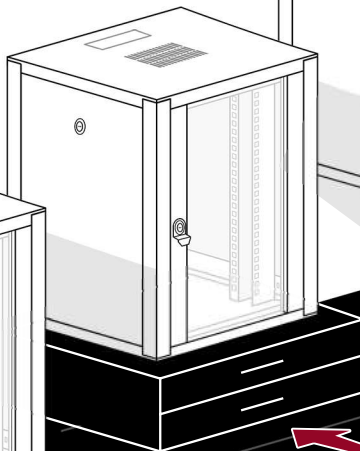
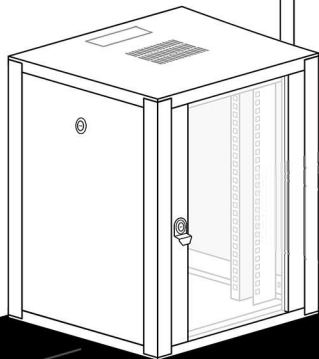
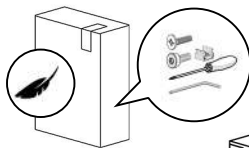
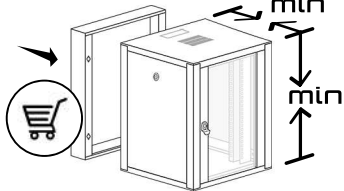

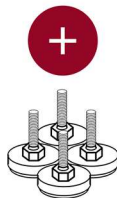

EN Adjustable feet
PT Pés ajustáveis
ES Pies ajustables
RU Ножки



EN Shelves
PT Prateleiras
ES Estantería
RU Полки

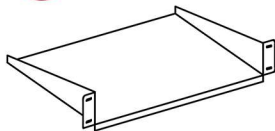

EN Blank panels
PT Painéis em branco
ES Paneles en blanco
RU Фальшпанели

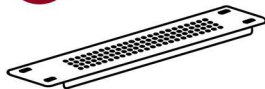

EN Additional section
PT Seção adicional
ES Sección adicional
RU Дополнительная секция

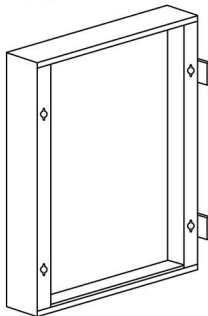

EN Cable Management
PT Gerenciamento de cabos
ES Manejo del cable
RU Кабельный организатор



EN Back panel
PT Painel traseiro
ES Panel posterior
RU Задняя панель

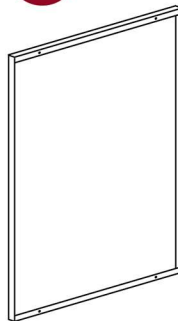

EN Cable entry brush
PT Escova de entrada de cabo
ES Cepillo de entrada de cable
RU Пылезащитная щетка

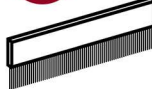

EN Accessories not included
ES Accesorios no incluidos

PT Acessórios não incluídos
RU Дополнительные аксессуары

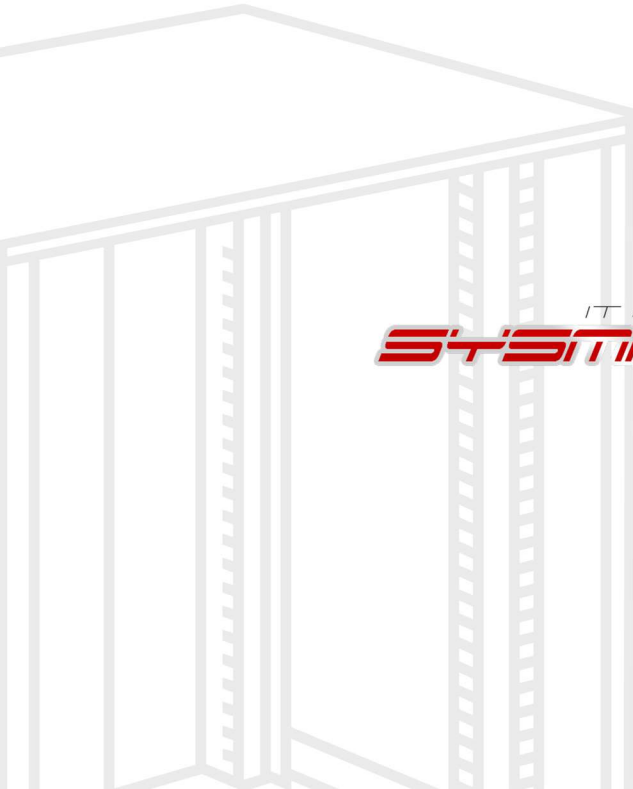

IT enclosures
SYSTEMATRIX